

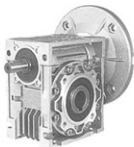

RV...FC



表示蜗杆尾部输出

RV...FD

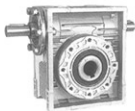

表示轴入蜗杆尾部输出

RV...DZ1



表示配单轴输出为左方向

RV...FB...DZ1

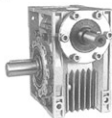

表示轴入配单向输出轴为左方向

RV...DZ2

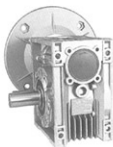

表示配单轴输出为右方向

RV...FB...DZ2

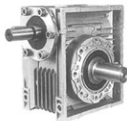

表示轴入配单向输出轴为右方向

RV...SZ

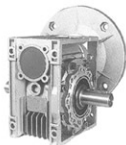

表示配双轴输出为左右方向

RV...FB...SZ

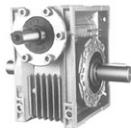

表示轴入配双轴输出为左右方向



RV...F4



RV...F4



RV...F5

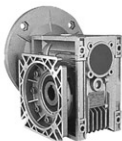

RV...F5



RV...A1

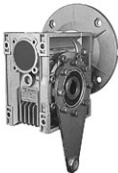

RV...A1



RV...A2



RV...A2





## 一、概述

RV系列蜗轮蜗杆减速器系按Q/MD1-2000技术质量标准设计制造。

产品在符合国家标准GB10085-88圆柱蜗轮蜗杆参数基础之上，吸取国内外最先进科技，独具新颖一格的“方箱型”外形结构，箱体外形美观，以优质铝合金压铸而成，具有以下优势性能：

- ◆ 机械结构紧凑、体积外形轻巧、小型高效；
- ◆ 热交换性能好，散热快；
- ◆ 安装简易、灵活轻捷、性能优越、易于维护检修；
- ◆ 运行平稳、噪音小、经久耐用；
- ◆ 适用性强、安全可靠性能大。

本产品目前已广泛应用于各类行业生产工艺装备的机械减速装置，深受用户的好评、是目前现代工业装备实现大扭矩、大速比低噪音、高稳定机械减速传动控制装置的最佳选择。

## 二、结构图

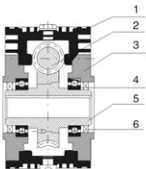

- 1、箱体
- 2、蜗杆
- 3、左右法兰
- 4、轴承
- 5、蜗轮组件
- 6、油封

## 三、各RV系列蜗轮蜗杆减速机

### 1、型号表示式

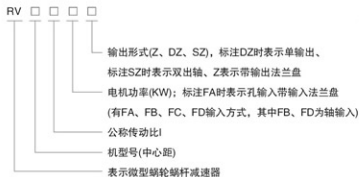

### 2、示例

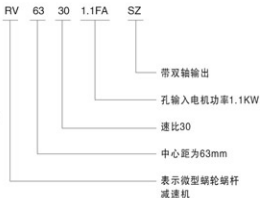



## 四、输入输出图表

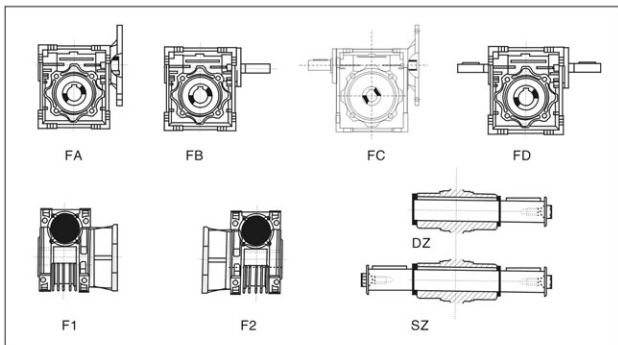

## 五、安装型式

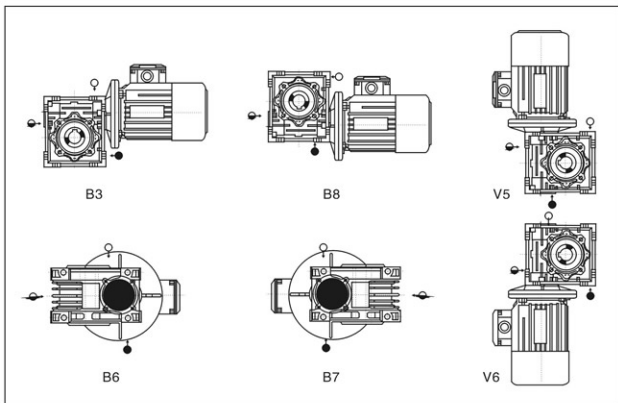



## 六、转矩功率参数表(配4极1400RPM电机)

中心距	i	$n_2$	KW	$M_2$	中心距	i	$n_2$	KW	$M_2$	中心距	i	$n_2$	KW	$M_2$
25	7.5	186.7	0.09	4.0	30	7.5	186.7	0.18	7.0	40	7.5	186.7	0.37	16
	10	140	0.09	5.0		10	140	0.18	9.0		10	140	0.37	27
	15	93.3	0.09	7.0		15	93.3	0.18	13		15	93.3	0.37	28
	20	70	0.09	9.0		20	70	0.18	17		20	70	0.37	39
	30	46.7	0.09	12		25	56	0.18	21		25	56	0.37	47
	40	35	0.09	15		30	46.7	0.18	24		30	46.7	0.37	53
	50	28	0.06	12		40	35	0.12	19		40	35	0.25	44
	60	23.3	0.06	14		50	28	0.12	23		50	28	0.25	47
						60	23.3	0.09	19		60	23.3	0.18	43
						80	17.5	0.06	14		80	17.5	0.12	34
								100	14	0.12	38			

中心距	i	$n_2$	KW	$M_2$	中心距	i	$n_2$	KW	$M_2$	中心距	i	$n_2$	KW	$M_2$
50	7.5	186.7	0.75	33	63	7.5	186.7	1.50	68	75	7.5	186.7	4.0	182
	10	140	0.75	42		10	140	1.50	88		10	140	3.0	180
	15	93.3	0.75	58		15	93.3	1.50	126		15	93.3	3.0	261
	20	70	0.75	81		20	70	1.50	166		20	70	2.20	240
	25	56	0.55	71		25	56	1.10	146		25	56	1.50	205
	30	46.7	0.55	81		30	46.7	1.10	167		30	46.7	1.50	249
	40	35	0.55	101		40	35	1.10	207		40	35	1.10	216
	50	28	0.37	80		50	28	0.55	124		50	28	1.10	264
	60	23.3	0.37	89		60	23.3	0.55	140		60	23.3	1.10	279
	80	17.5	0.25	72		80	17.5	0.37	115		80	17.5	0.55	180
100	14	0.18	60	100	14	0.37	129	100	14	0.55	206			

中心距	i	$n_2$	KW	$M_2$	中心距	i	$n_2$	KW	$M_2$	中心距	i	$n_2$	KW	$M_2$
90	7.5	186.7	4.0	180	110	7.5	186.7	7.50	345	130	7.5	186.7	7.50	343
	10	140	4.0	296		10	140	7.50	455		10	140	7.50	453
	15	93.3	4.0	342		15	93.3	5.50	484		15	93.3	7.50	664
	20	70	4.0	458		20	70	5.50	638		20	70	7.50	864
	25	56	3.0	420		25	56	5.50	790		25	56	7.50	1074
	30	46.7	3.0	479		30	46.7	4.0	647		30	46.7	5.50	900
	40	35	2.20	433		40	35	3.0	638		40	35	5.50	1171
	50	28	2.20	492		50	28	3.0	767		50	28	5.50	1379
	60	23.3	1.50	424		60	23.3	2.20	648		60	23.3	4.0	1179
	80	17.5	1.10	365		80	17.5	1.50	548		80	17.5	2.20	816
100	14	0.75	302	100	14	1.10	473	100	14	2.20	963			

中心距	i	$n_2$	KW	$M_2$	注:	单位	Note	unit
150	7.5	186.7	15	699	$n_1$ =输入速度	RPM	$n_1$ =input	speed
	10	140	15	922	$n_2$ =输出速度	RPM	$n_2$ =output	speed
	15	93.3	15	1352	$M_2$ =输出扭矩	NM	$n_2$ =output	torque
	20	70	7.5	871	$i$ =传动比			
	25	56	7.5	1064	(带*的机型有5可选)			
	30	46.7	7.5	1191				
	40	35	5.5	1165				
	50	28	5.5	1459				
	60	23.3	4.0	1208				
	80	17.5	3.0	1148				
100	14	3.0	1306					



## 七、减速机出力轴的许可径向加载力 (N)

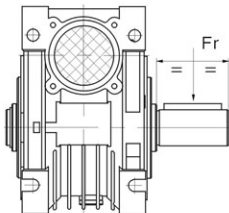

减速比	输出转速	RV30	RV40	RV50	RV63	RV75	RV90	RV110	RV130
5	280	599	1149	1586	2062	2428	2687	3389	4433
7.5	186	691	1325	1829	2378	2799	3098	3908	5112
10	140	758	1454	2007	2609	3072	3400	4288	5610
15	94	868	1665	2298	2988	3518	3893	4910	6424
20	70	954	1829	2525	3283	3865	4277	5395	7057
25	56	1033	1981	2735	3556	4187	4633	5844	7645
30	47	1088	2087	2881	3745	4410	4880	6155	8052
40	35	1204	2309	3188	4145	4880	5401	6812	8912
50	28	1296	2485	3431	4461	5252	5812	7331	9590
60	24	1381	2649	3658	4756	5599	6169	7815	10224
80	18	1516	2907	4014	5218	6144	6799	8576	11219
100	14	1638	3142	4338	5639	6639	7348	9268	12124

- 表中的数值为作用于出力轴中点的许可加载力。
- 当减速机为双出轴时，折算到轴端的径向全力不能超过表中规定的数值。
- 当径向力和轴向力同时施加时，最大许可的轴向推力为径向力的1/5。

## 八、减速机的电机配合接口

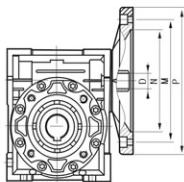

	法兰规格	N		M		P		5	7.5	10	15	20	25	30	40	50	60	80	100
		B5	B14	B5	B14	B5	B14												
RV30	56B5/B14	80	50	100	65	120	80	9	9	9	9	9	9	9	9	9	9	9	-
	63B5/B14	95	60	115	75	140	90	11	11	11	11	11	11	11	11	11	11	11	-
RV40	56B5	80	-	100	-	120	-	-	-	-	-	-	-	-	-	9	9	9	9
	63B5/B14	95	60	115	75	140	90	11	11	11	11	11	11	11	11	11	11	11	11
RV50	71B5/B14	110	70	130	85	160	105	14	14	14	14	14	14	14	14	14	14	14	-
	63B5	95	-	115	-	140	-	-	-	-	-	-	-	-	-	11	11	11	11
RV63	71B5/B14	110	70	130	85	160	105	-	-	-	-	-	-	-	14	14	14	14	14
	80B5/B14	130	80	165	100	200	120	19	19	19	19	19	19	19	19	19	19	19	19
RV75	71B5/B14	110	70	130	85	160	105	-	-	-	-	-	-	-	14	14	14	14	14
	80B5/B14	130	80	165	100	200	120	-	19	19	19	19	19	19	19	19	19	19	19
RV90	90B5/B14	130	95	165	115	200	140	-	24	24	24	24	24	24	-	-	-	-	-
	80B5/B14	130	80	165	100	200	120	-	-	-	-	-	-	-	19	19	19	19	19
RV110	90B5/B14	130	95	165	115	200	140	-	24	24	24	24	24	24	-	-	-	-	-
	100B5/B14	180	110	215	130	250	160	-	28	28	28	28	28	28	-	-	-	-	-
RV130	112B5/B14	180	110	215	130	250	160	-	28	28	28	28	28	28	-	-	-	-	-
	80B5/B14	130	80	165	100	200	120	-	-	-	-	-	-	-	19	19	19	19	19
RV150	90B5/B14	130	95	165	115	200	140	-	-	-	-	-	-	-	24	24	24	24	24
	100B5/B14	180	110	215	130	250	160	-	28	28	28	28	28	28	-	-	-	-	-
RV110	112B5/B14	180	110	215	130	250	160	-	28	28	28	28	28	28	-	-	-	-	-
	132B5	230	-	265	-	300	-	-	38	38	38	38	38	38	-	-	-	-	-
RV130	90B5	130	-	265	-	200	-	-	-	-	-	-	-	-	24	24	24	24	24
	100B5	180	-	215	-	250	-	-	28	28	28	28	28	28	28	28	28	28	28
RV150	112B5	180	-	215	-	250	-	-	28	28	28	28	28	28	28	28	28	28	28
	132B5	230	-	265	-	300	-	-	38	38	38	38	38	38	38	38	38	38	38
RV150	100B5	180	-	215	-	250	-	-	-	-	-	-	-	-	28	28	28	28	28
	112B5	180	-	215	-	250	-	-	-	-	-	-	-	-	28	28	28	28	28
RV150	132B5	230	-	265	-	300	-	-	-	-	-	-	-	-	38	38	38	38	38
	160B5	250	-	300	-	350	-	-	42	42	42	42	42	42	-	-	-	-	-



## 尺寸

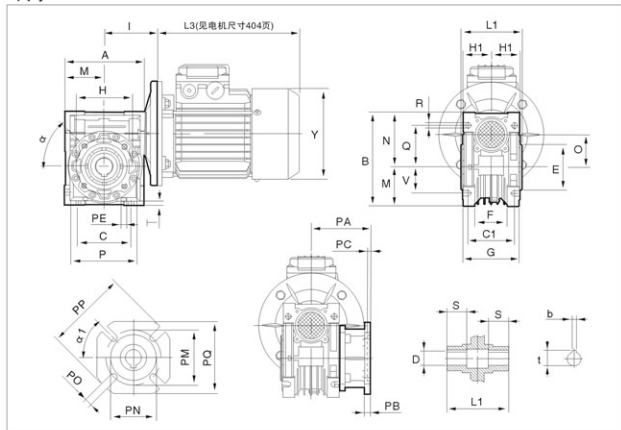

带轴输出请参照190页DZ、SZ尺寸

中心距	A	B	C	C1	D(Hr)	E(hs)	F	G	H	H <sub>1</sub>	I	L <sub>1</sub>	M	N	O	P	Q	R
30	80	97	54	44	14	55	32	56	65	29	55	63	40	57	30	75	44	6.5
40	100	121.5	70	60	18(19)	60	43	71	75	36.5	70	78	50	71.5	40	87	55	6.5
50	120	144	80	70	25(24)	70	49	85	85	43.5	80	92	60	84	50	100	64	8.5
63	144	174	100	85	25(28)	80	67	103	95	53	95	112	72	102	63	110	80	8.5
75	172	205	120	90	28(35)	95	72	112	115	57	112.5	120	86	119	75	140	93	11
90	206	238	140	100	35(38)	110	74	130	130	67	129.5	140	103	135	90	160	102	13
110	252.5	295	170	115	42	130	-	144	165	74	160	155	127.5	167.5	110	200	125	14
130	292.5	335	200	120	45	180	-	155	215	81	180	170	147.5	187.5	130	250	140	16
150	340	400	240	145	50	180	-	185	215	96	210	200	170	230	150	250	180	16

中心距	S	T	V	PA	PB	PC	PE	PM	PN(Hs)	PO	PP	PQ	b	t	$\alpha$	$\alpha_1$	Kg.
30	21	5.5	27	54.5	6	4	M6 × 11(n=4)	68	50	6.5(n=4)	80	70	5	16.3	0°	45°	1.2
40	26	6.5	35	67	7	4	M6 × 8(n=4)	75	60	9(n=4)	110	95	6	20.8(21.8)	45°	45°	2.3
50	30	7	40	90	9	5	M8 × 10(n=4)	85	70	11(n=4)	125	110	8	28.3(27.3)	45°	45°	3.5
63	36	8	50	82	10	6	M8 × 14(n=4)	150	115	11(n=4)	180	142	8	28.3(31.3)	45°	45°	6.2
75	40	10	60	111	13	6	M8 × 14(n=4)	165	130	14(n=4)	200	170	8	31.3(38.3)	45°	45°	9
90	45	11	70	111	13	6	M10 × 18(n=8)	175	152	14(n=8)	210	200	10	38.3(41.3)	45°	45°	13
110	50	14	85	131	15	6	M10 × 18(n=8)	230	170	14(n=8)	280	260	12	45.3	45°	45°	35
130	60	15	100	140	15	6	M12 × 21(n=8)	255	180	16(n=6)	320	290	14	48.8	45°	45°	48
150	72.5	18	120	155	15	6	M12 × 21(n=8)	255	180	16(n=6)	320	290	14	53.8	45°	22.5°	87

注：重量（Kg.）不包含电机的重量。



# 外型安装尺寸

# RV系列铝合金蜗轮蜗杆减速机

## 尺寸

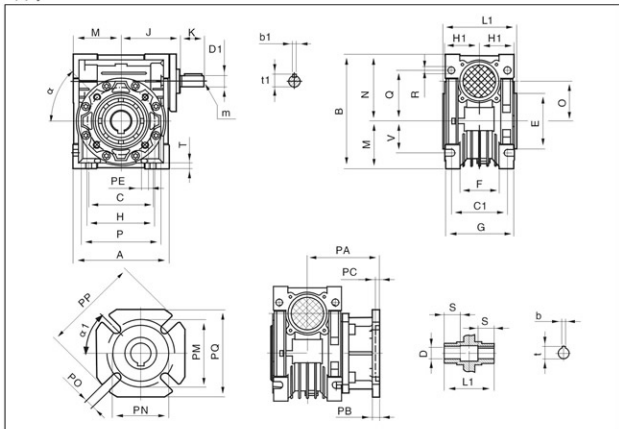

带轴输出请参照190页DZ, SZ尺寸

中心距	A	B	C	C <sub>1</sub>	D(H7)	D <sub>1</sub> (js6)	E(h8)	F	G	H	H <sub>1</sub>	J	K	L <sub>1</sub>	M	N	O	P	Q	R
30	80	97	54	44	14	9	55	32	56	65	29	51	20	63	40	57	30	75	44	6.5
40	100	121.5	70	60	18(19)	11	60	43	71	75	36.5	60	23	78	50	71.5	40	87	55	6.5
50	120	144	80	70	25(24)	14	70	49	85	85	43.5	74	30	92	60	84	50	100	64	8.5
63	144	174	100	85	25(28)	19	80	67	103	95	53	90	40	112	72	102	63	110	80	8.5
75	172	205	120	90	28(35)	24	95	72	112	115	57	105	50	120	86	119	75	140	93	11
90	206	238	140	100	35(38)	24	110	74	130	130	67	125	50	140	103	135	90	160	102	13
110	252.5	295	170	115	42	28	130	-	144	165	74	142	60	155	127.5	167.5	110	200	125	14
130	292.5	335	200	120	45	30	180	-	155	215	81	162	80	170	147.5	187.5	130	250	140	16
150	340	400	240	145	50	35	180	-	185	215	96	195	80	200	170	230	150	250	180	18

中心距	S	T	V	PA	PB	PC	PE	PM	PN(Ha)	PO	PP	PQ	b	b <sub>1</sub>	t	t <sub>1</sub>	m	α	α <sub>1</sub>	Kg
30	21	5.5	27	54.5	6	4	M6 × 11(n=4)	68	50	6.5(n=4)	80	70	5	3	16.3	10.2	-	0°	45°	1.2
40	26	6.5	35	67	7	4	M6 × 8(n=4)	75	60	9(n=4)	110	95	6	4	20.8	12.5	-	45°	45°	2.3
50	30	7	40	90	9	5	M8 × 10(n=4)	85	70	11(n=4)	125	110	8	5	28.3	16.0	M6	45°	45°	3.5
63	36	8	50	82	10	6	M8 × 14(n=8)	150	115	11(n=4)	180	142	8	6	28.3	21.5	M6	45°	45°	6.2
75	40	10	60	111	13	6	M8 × 14(n=8)	165	130	14(n=4)	200	170	8	8	31.3	27.0	M8	45°	45°	9
90	45	11	70	111	13	6	M10 × 18(n=8)	175	152	14(n=8)	210	200	10	8	38.3	27.0	M8	45°	45°	13
110	50	14	85	131	15	6	M10 × 18(n=8)	230	170	14(n=8)	280	260	12	8	45.3	31.0	M10	45°	45°	35
130	60	15	100	140	15	6	M12 × 21(n=8)	255	180	16(n=6)	320	290	14	8	48.8	33.0	M10	45°	45°	48
150	72.5	18	120	155	15	6	M12 × 21(n=8)	255	180	16(n=6)	320	290	14	10	53.8	38	M12	45°	22.5°	87

注：加长输出法兰有RV40、RV50、RV63三种，都是加长30mm。



# RV系列组合蜗轮安装方式



## 一、双级RV系列蜗轮蜗杆减速机

### 1、外观结构

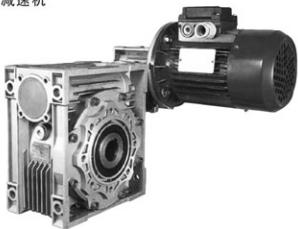

### 2、型号表示式



### 3、示例

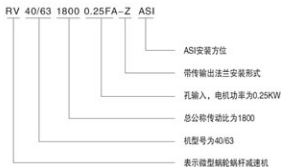

## 二、带电机安装型式

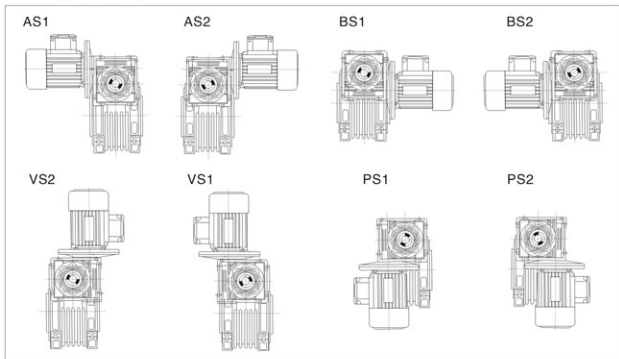

 二、性能参数( $n_1=1400r/min$ )

KW	RV+RV	I	$n_2(r/min)$	$M_2(N.M)$	$i_1$	$i_2$
0.06KW	RV30/40	300	4.7	68.7	10	30
	RV30/40	400	3.5	90.7	10	40
	RV30/40	500	2.8	101.6	20	25
	RV30/40	600	2.3	111.5	20	30
	RV30/40	750	1.9	145.0	25	30
	RV30/40	900	1.6	165.8	30	30
	RV30/50			174.7	30	30
	RV30/40	1200	1.2	218.8	30	40
	RV30/50			227.0	30	40
	RV30/40	1500	0.9	234.9	50	30
	RV30/50			247.5	50	30
	RV30/63			270.2	30	50
	RV30/40			258.6	60	30
	RV30/50	1800	0.8	272.3	60	30
	RV30/63			280.6	30	60
	RV30/40	2400	0.6	341.2	60	40
	RV30/50			353.9	60	40
	RV30/63			365.7	60	40
	RV30/75			388.7	60	40
	RV30/40	3000	0.5	385.6	60	50
RV30/50	404.8			60	50	
RV30/63	421.4			60	50	
RV40/75	485.3			60	50	
RV30/40	3200	0.4	369.2	80	40	
RV30/40	300	4.7	103.1	10	30	
RV30/50	400	3.5	141.1	10	40	
RV30/50	500	2.8	161.3	10	50	
RV30/50	600	2.3	176.2	20	30	
RV30/50	750	1.9	229.1	25	30	
RV30/63	900	1.6	272.7	30	30	
RV30/63	1200	1.2	351.8	30	40	
RV40/75	1500	0.9	450.5	50	30	
RV40/75	1800	0.8	460.0	60	30	
RV40/90	2400	0.6	579.0	60	40	
RV40/90	3000	0.5	688.2	60	50	
RV30/50	300	4.7	144.7	10	30	
RV30/50	400	3.5	188.1	10	40	
RV30/63	500	2.8	223.9	10	50	
RV30/63	600	2.3	275.0	15	40	
RV30/63	750	1.9	316.8	15	50	
RV40/75	900	1.6	402.8	30	30	
RV30/63	1200	1.2	469.1	30	40	
RV40/75			510.5	30	40	
RV40/90	1500	0.9	602.5	30	50	
RV40/90	1800	0.8	686.2	30	60	
RV40/90	2400	0.6	772.4	60	40	
RV50/110	3000	0.5	1003.2	60	50	
RV30/50	300	4.7	217.1	10	30	
RV30/63	400	3.5	291.5	10	40	
RV30/63	500	2.8	335.9	10	50	
RV40/75	600	2.3	472.6	20	30	
0.18KW	RV40/75	750	1.9	550.4	25	30
	RV40/90	900	1.6	599.7	30	30
	RV40/90	1200	1.2	760.8	30	40
	RV40/90	1500	0.9	903.7	30	50
	RV50/110	1800	0.8	932.3	60	30
	RV50/110	2400	0.6	1216.4	60	40
	RV40/75	300	4.7	347.6	10	30
	RV40/75	400	3.5	440.6	10	40
	RV40/75	500	2.8	550.1	10	50
	RV40/90	600	2.3	639.0	15	40
	RV40/90	750	1.9	790.7	15	50
	RV40/90	900	1.6	900.6	15	60
0.25KW	RV50/110	1200	1.2	1129.0	30	40
	RV50/110	1500	0.9	1285.9	50	30
	RV50/110	1800	0.8	1294.9	60	30
	RV63/130	2400	0.6	1820.3	60	40
	RV63/130	3000	0.5	2214.1	60	50
	RV40/75	300	4.7	514.5	10	30
	RV40/90			499.3	7.5	40
	RV40/90	400	3.5	647.9	10	40
	RV40/90	500	2.8	769.7	10	50
	RV40/90	600	2.3	932.5	15	40
	RV50/110	750	1.9	1157.2	25	30
	RV50/110	900	1.6	1230.6	30	30
RV63/130	1200	1.2	1741.2	40	30	
RV63/130	1500	0.9	2006.2	50	30	
RV63/130	1800	0.8	2082.8	60	30	
RV50/110	300	4.7	760.4	10	30	
RV50/110	400	3.5	992.1	10	40	
RV50/110	500	2.8	1227.3	10	50	
RV50/110	600	2.3	1411.3	15	40	
RV50/110	750	1.9	1720.2	25	30	
RV63/130	1200	1.6	2595.0	30	40	
RV50/110	300	4.7	1036.9	10	30	
RV50/110	400	3.5	1352.9	10	40	
RV63/130	500	2.8	1686.7	10	50	
RV63/130	600	2.3	1984.5	15	40	
RV63/130	750	1.9	2403.0	25	30	
RV63/130	900	1.6	2735.8	30	30	
RV63/130	300	4.7	1572.5	10	30	
RV63/130	400	3.5	2033.9	10	40	
RV63/130	300	4.7	2144.3	10	30	

注: KW: 功率

 $i_1$ 、 $i_2$ : 传动比

 $n_2$ : 输出转速

 $M_2$ : 输出扭矩





蜗轮尾出轴 (E) 尺寸

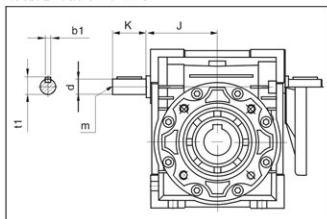

中心距	J	d(j6)	K	m	b1	t1
30	45	9	20	-	3	10.2
40	53	11	23	-	4	12.5
50	64	14	30	M6	5	16
63	75	19	40	M6	6	21.5
75	90	24	50	M8	8	27
90	108	24	50	M8	8	27
110	135	28	60	M10	8	31
130	155	30	80	M10	8	33
150	175	35	80	M12	10	38

蜗轮输出轴 (DZ, SZ) 尺寸

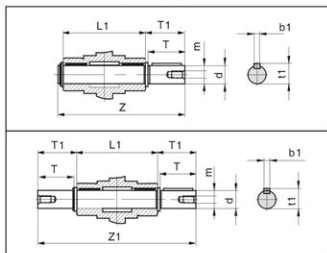

中心距	d(h6)	T	T1	L1	Z	Z1	m	b1	t1
30	14	30	32.5	63	102	128	M6	5	16
40	18	40	43	78	128	164	M6	6	20.5
50	25	50	53.5	92	153	199	M10	8	28
63	25	50	53.5	112	173	219	M10	8	28
75	28	60	63.5	120	192	247	M10	8	31
90	35	80	84.5	140	234	309	M12	10	38
110	42	80	84.5	155	249	324	M16	12	45
130	45	80	85	170	265	340	M16	14	48.5
150	50	82	87	200	297	374	M16	14	53.5

扭力臂 (A) 尺寸

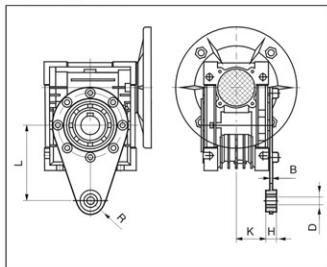

中心距	L	H	K	D	R	B
30	85	14	24	8	15	4
40	100	14	31.5	10	18	4
50	100	14	38.5	10	18	4
63	150	14	49	10	18	6
75	200	25	47.5	20	30	6
90	200	25	57.5	20	30	6
110	250	30	62	25	35	6
130	250	30	69	25	35	6
150	250	30	84	25	35	8